



Split-type heat pump

ECOs HEAT ONYX



Installation and operation manual for ECOs HEAT ONYX Split-Type Outdoor Unit

As a result of continuous product development, the manufacturer reserves the right to make changes to the products and technical documentation for the devices.

Please carefully read this manual before operating the device. Keep this user manual throughout the entire period of device usage for reference whenever needed.

1 Safety Precaution

Warning

Warning: This air conditioner uses R32 flammable refrigerant.

Notes: Air conditioner with R32 refrigerant, if roughly treated, may cause serious harm to the human body or surrounding things.

- * The room space for the installation, use, repair, and storage of this air conditioner should be greater than 15m².
- * Do not use any methods to speed up defrost or to clean frosty parts except for particular recommended by manufacturer.
- * Not pierce or burn air conditioner, and check the refrigerant pipeline whether be damaged.
- * The air conditioner should be stored in a room without lasting fire source, for example, open flame, burning gas appliance, working electric heater and so on.
- * Notice that the refrigerant may be tasteless.
- * The storage of air conditioner should be able to prevent mechanical damage caused by accident.
- * Maintenance or repair of air conditioners using R32 refrigerant must be carried out after security check to minimize risk of incidents.
- * Air conditioner must be installed with stop valve cover.
- * Please read the instruction carefully before installing, using and maintaining.



* The room space and refrigerant maximum charge requirements are shown below:

Room space (m ²)	Refrigerant maximum charge requirements (kg)
15-20	4.85
21-27	5.73
28-31	6.62
32-49	7.08
50-55	8.85
≥56	9.37

* If Ceiling & Floor air conditioner unit use Wall-Mounted installation ,the room space and refrigerant maximum charge requirements are shown below:

Room space (m ²)	Refrigerant maximum charge requirements (kg)
21-27	1.56
28-31	1.81
32-49	1.93
50-55	2.41
≥56	2.55

Incorrect operation due to ignoring instruction will cause harm or damage. The seriousness is classified by the following indications:

WARNING

This symbol indicates the possibility of death or serious injury.

CAUTION

This symbol indicates the possibility of injury or damage to properties only.

WARNING

This appliance can be used by children aged from 8 years and above and persons with reduced physical, sensory or mental capabilities or lack of experience and knowledge if they have been given supervision or instruction concerning use of the appliance in a safe way and understand the hazards involved. Children shall not play with the appliance. Cleaning and user maintenance shall not be made by children without supervision.(Only for the AC with CE-MARKING)

This appliance is not intended for use by persons (including children) with reduced physical, sensory or mental capabilities, or lack of experience and knowledge, unless they have been given supervision or instruction concerning use of the appliance by a person responsible for their safety. Children should be supervised to ensure that they do not play with the appliance. (Except for the AC with CE-MARKING)



The air conditioner must be grounded. Incomplete grounding may result in electric shocks. Do not connect the earth wire to the gas pipeline, water pipeline, lightning rod, or telephone earth wire.

Don't pull out the power plug during operating or with wet hands.
It can cause electric shock or fire.



The appliance shall be installed in accordance with national wiring regulations.

Don't pull the power cord when pull out the power plug.
The damage of pulling power cord will cause serious electric shock.



The power plug must be inserted tightly.
Otherwise, it can cause electric shock or overheating, even fire.



Don't share the socket with other electric appliance, and use the broken or unstandord cord.
Otherwise, it can cause electric shock even fire.

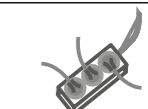

Clean the dust on the plug regularly.
Otherwise the dust mixed, humidity will result in insulation fault even fire.



An earth leakage breaker with rated capacity must be installed to avoid possible electric shocks.



Cut off the main power switch when not using the unit for a long time. Otherwise, it may cause product failure or fire.



WARNING

Stop operation and cut off the main power in storm or hurricane. Operation with windows opened may cause electric shock.

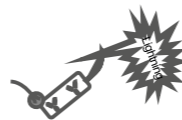

Don't install air conditioner in a place where there is flammable gas or liquid. The distance between them should be above 1m.

It may cause fire.



Don't put a finger, a rod or other object into the air outlet or inlet.

As a fan is rotating at a high speed, it will cause injury.

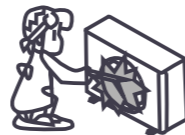

Don't touch the swinging wind vanes.

It may clamp your finger and damage the driving parts of the wind vanes.

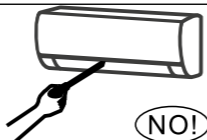

Don't attempt to repair the air conditioner by yourself.

You may be hurt or cause further malfunctions.

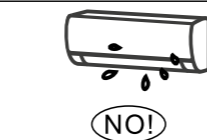

Take care not let the remote control and the indoor unit watered or being too wet, or may short circuit even caused fire.

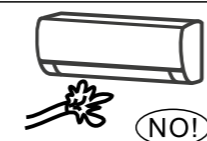

Don't use liquid or corrosive cleaning agent wipe the air-conditioner and sprinkle water or other liquid either. Otherwise the inclosure will be damaged even electric shock.

If the power supply cord is damaged, it must be replaced by the manufacture or its service agent or a similar qualified person.

- The refrigerant R410A leakage contributes to climate change. Refrigerant with lower global warming potential (GWP) would contribute less to global warming than a refrigerant with higher GWP, if leaked to the atmosphere. This appliance contains a refrigerant fluid with a GWP equal to [2088]. This means that if 1 kg of this refrigerant fluid would be leaked to the atmosphere, the impact on global warming would be [2088] times higher than 1 kg of CO₂, over a period of 100 years. Never try to interfere with the refrigerant circuit yourself or disassemble the product yourself and always ask a professional.

WEEE Warning

Meaning of crossed out wheeled dustbin:

Do not dispose of electrical appliances as unsorted municipal waste, use separate collection facilities.

Contact your local government for information regarding the collection systems available.

If electrical appliances are disposed of in landfills or dumps, hazardous substances can leak into the groundwater and get into the food chain, damaging your health and well-being.

When replacing old appliances with new ones, the retailer is legally obligated to take back your old appliance for disposals at least free of charge.



2 Operation and Performance

three-minutes protection

It should take about three minutes to re-start the unit after stop running or re-run the unit with manual switch. This is the self-protection of the compressor.

Defrost in Heating Mode

1. On heating model, outdoor machines occur the frost phenomenon, in order to improve the heating effect, automatic running defrost operation (about 2~10 minutes), the drainage vent from the outdoor unit.
2. On the defrosting mode, the outdoor fan motor stop running .

Heating Capacity

1. The system is absorbing heat from the outside, and releasing them to the indoor, once the outdoor temperature become lower, then the heating capacity will be lower.
2. Proposed use other heating equipments together when outdoor temperature is too low.
3. In the alpine areas where has a particularly low temperature, the heating effect will be even better if the indoor unit has auxiliary electric heating device.(Please read the detailed from Indoor Unit Manual)

Protection Device (High Voltage Switch)

This device terminate running automatically during a compulsory working. Protection device moves circumstances, stop running, and show the trouble code. In the event of the following circumstances, the protection of installations is activated.

Cooling: Outdoor unit's inlet or outlet was full of plug. Sustained strong winds blow to the outdoor unit's tuyere.

Heating: Indoor unit's filter conglutinate too much excessive dust and litter.

NOTE:

When protection device actions, please manually cut off the power switch, do not restart it till founded the reasons.

3 Outdoor Unit Installation

Note:

- Installation professionals commissioned. Others possible to install the installation imperfections, which led to the leakage, electric shock or a fire officer.
- Avoid direct sunlight or other heat source, and if necessary a sun shelter should be mounted.
- The sites must be provide bearing surface level and enough firm to support the weight of outdoor unit.
- Install the unit is firm, otherwise it will caused abnormal noise and vibration by bad installation.
- The installation location must ensure air discharge and operation noise of unit can't disturb neighbors.
- Installation location to avoid fire hazard caused by flammable gas leakage.
- As far as possible move to a nearby obstacles, in order to prevent air circulation scope is too small and affect the unit performance.
- Meet the requirements of installation, try to install near the location of the indoor unit.
- Installation or high winds in the seaside, in order to ensure the normal operation of the fan, want to rely on outdoor wall installation, please use the panel if necessary.
- In strong wind areas, to prevent the wind blow, blow into the outdoor.
- Hang a wall to install is prohibited.

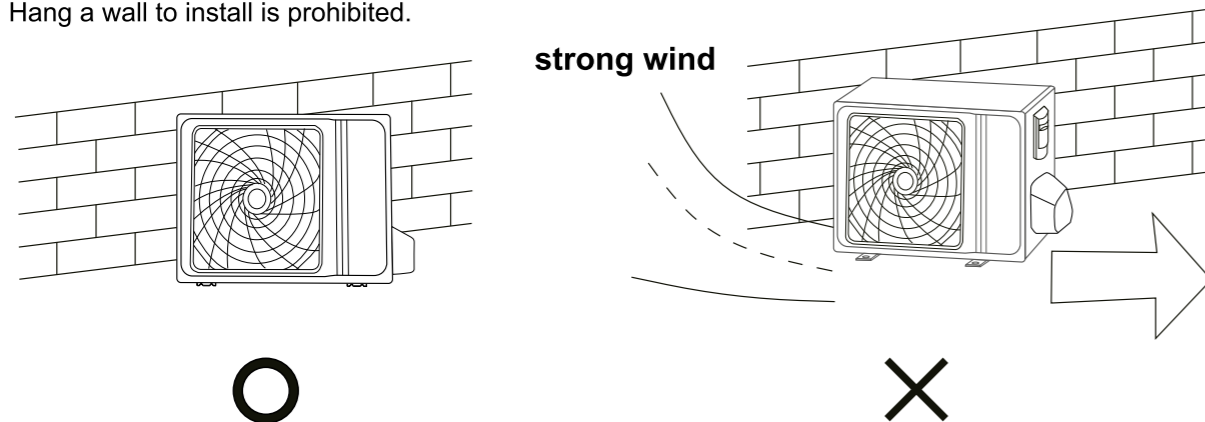

Installation Space

Space required for installation and maintenance, as following figure.

unit : mm

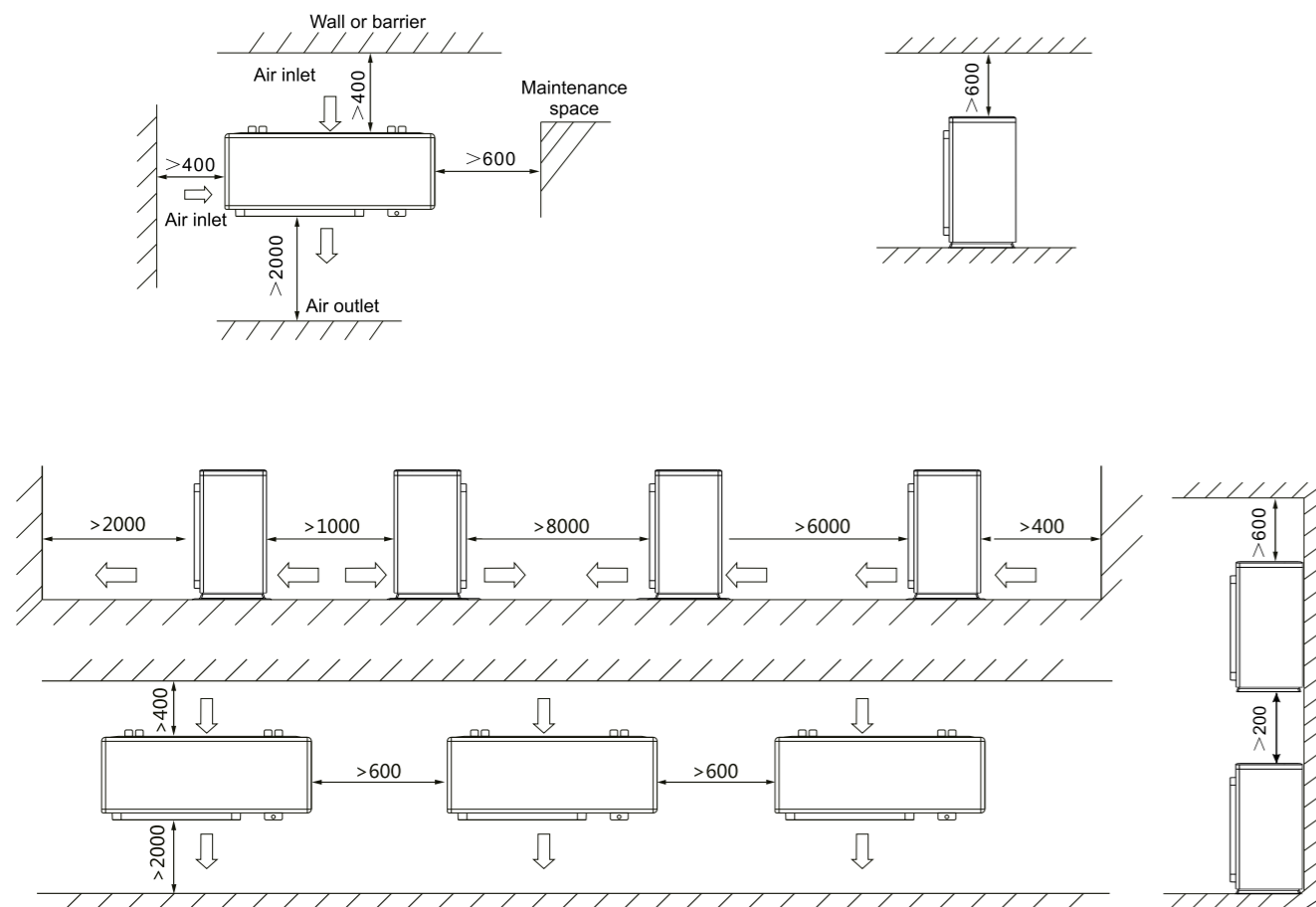

Outdoor unit lifting

1. With more than 8 m two rope lifting in packing condition, keep the balance of the unit, safety steadily rising. In the absence of packaging or packaging damaged handling application plate or packaging for protection.
2. Lifting outdoor unit take care of the barycenter, in case of sliding and dumping. Unit the center of gravity is not in the center, should not be greater than 30° , and pay attention to safety in the process of handling, hoisting. As figure.
3. Please do not hold the shell of the wind net, otherwise it will make its deformation.
4. Please note that don't make the hand or other objects in contact with the rotor blades.
5. Don't lean over 45 degrees carrying, don't lie.

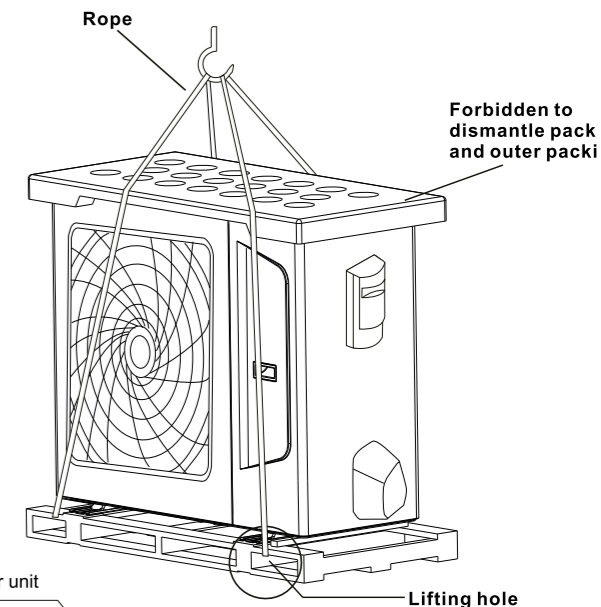

Outdoor unit foundation

1. The foundation can be made of channel steel or concrete. Reserve the space for discharging the condensate water from outdoor units.
2. Try not to use four-square base to support outdoor unit; rubber anti-vibration pads are necessary to avoid vibration.

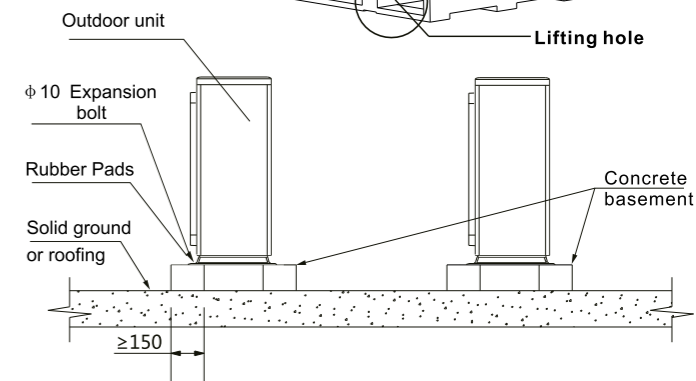

Dimension size

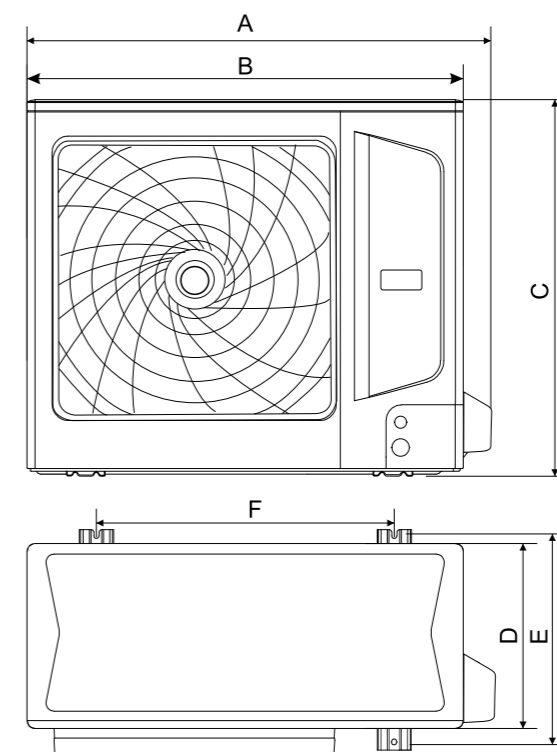

unit : mm

Model	A	B	C	D	E	F
4kW~6kW(1-phase)	963	895	694	343	388	632
8kW~10kW(1-phase)	1060	980	808	393	454	675
12kW~16kW(1-phase)	1070	1001	866	399	501	675
12kW~16kW(3-phase)	1070	1001	866	399	501	675

4 Connecting Pipe Installation

Refrigerant piping

1. Flaring

- With the pipe cutting knife to cut off the pipe .
- Connect the pipe sleeve nut flaring .

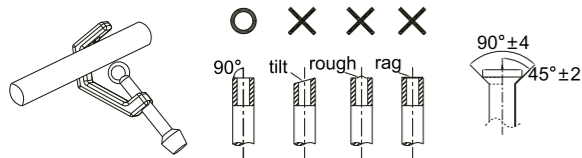

Outer Diameter (mm)	A (mm)	
	Max.	Min.
φ 6.4	8.7	8.3
φ 9.5	12.4	12.0
φ 12.7	15.8	15.4
φ 15.9	19.0	18.6
φ 19.1	23.3	22.9
φ 22.2	27.3	27.0

2. Clamp nut

Aimed at connecting piping, tight coupling nut by hand, and then using a wrench and tighten.

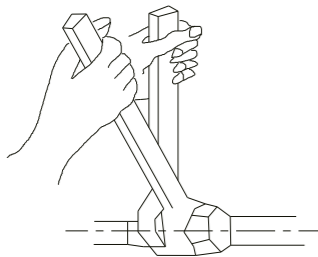

Pipe size	Tightening torque N.m
φ 6.4	14.2~17.2 N.m (144~179kgf.cm)
φ 9.5	32.7~39.9 N.m (333~407kgf.cm)
φ 12.7	49.5~60.3N.m (504~616kgf.cm)
φ 15.9	61.8~75.4 N.m (630~770kgf.cm)
φ 19.1	97.2~118.6 N.m (990~1210kgf.cm)
φ 22.2	109.5~133.7 N.m (1115~1364kgf.cm)

Note:

1. In order to prevent internal piping nitride, Nitrogen filling operations must be taken when the piping is welding, otherwise oxidation chip will plug the refrigerant cycling.
2. Excessive torque will damage pipe socket, and a small torque of the screw will leak, according to the installation conditions, .Please refer to table Tightening torque.

Connecting pipe diameter

Capacity	Diameter of main tube	
	Gas side(mm)	Liquid side(mm)
4kW~6kW	φ 15.9	φ 9.52
8kW~10kW	φ 15.9	φ 9.52
12kW~16kW	φ 15.9	φ 9.52

- step 1 : The connecting pipe into the copper nut.
- step2 : Welding with outdoor unit main pipe.
- step 3: Copper nano and stop valve connection.

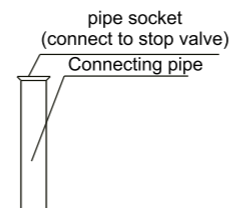

Piping size and connection Method

1. Permitted Piping Length and Level Difference

The piping length and level difference limitations that apply are summarized. Before installation, it is necessary to check if the piping length and height difference are meeting the requirements.

Models	4kW~16kW
Max. piping length	30m
Max. height difference when outdoor unit is upside	20m
Max. height difference when outdoor unit is downside	20m

2.Connection method

Note:

The largest level difference between indoor unit and outdoor unit should not exceed 20m.

If the outdoor unit is above and the level difference is greater than 20m, it is recommended that an oil return bend with dimensions as specified in Figure is set every 5m in the gas pipe of the main pipe

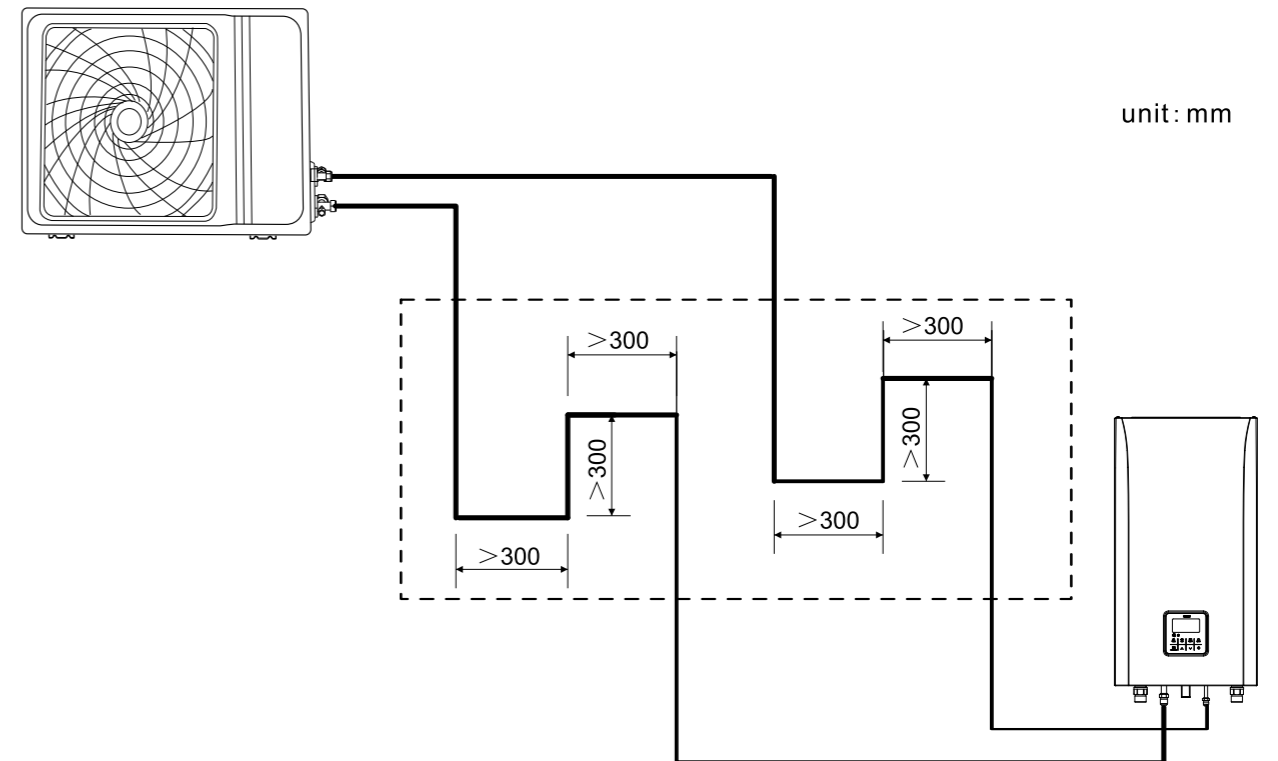

Remove the garbage and water from the piping

1. When installing the refrigerant piping, some garbage may enter into the pipe , so before connecting to the outdoor unit, cleaning should be taken.
2. Use high pressure nitrogen gas for cleaning, the refrigerant of outdoor unit is forbidden for cleaning.

Air tightness Test

1. After finishing the piping connection of outdoor unit, please connect the high pressure side piping and high pressure vavle.
2. Make the low pressure side piping and mater joints accessory well-welded.
3. Vacuum pump suction until the gage pressure to draw -1kgf/cm².
4. Charge the nitrogen(40kgf/cm²) gas from connection point of high side valve and master joints, Retain the pressure for about 24 hours.
5. After the leakage testing, please make the low pressure ball valve and low pressure valve well-welded.

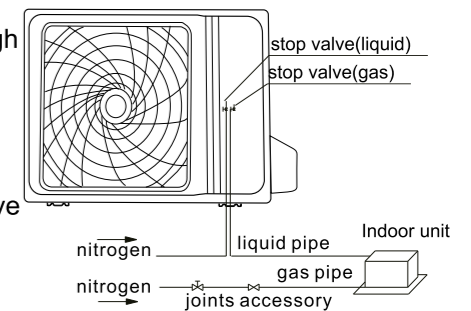

Note:

- The nitrogen gas(3.9MPa,40kgf/cm²) with a certain pressure is used for the leaking testing.
- It is forbidden directly to charge the nitrogen gas for stop valves(figure4.8).
- It is forbidden to use oxygen, flammable gas and poisonous gas.
- Use wet cloth to wrap the low pressure valve with welding.
- In order to prevent the equipment damage, the retain pressure time should not be too long.

Use Vacuum Pumps for Vacuuming

1. Use the vacuum pump which relative vacuum degree is -0.1 MPa, and the displacement is over 40L/min.
2. Do not open the stop outdoor unit valve of outdoor unit gas side and liquid side because of outdoor unit without vacuum.
3. Vacuum pump work more than 2 hours can achieve relatively vacuum under 0.1 Mpa. If more than 3 hours still can not reach below 0.1 Mpa, that were mixed with water or air, need to check.

Note:

- Different refrigerant tools and measuring instruments cannot be mixed use.
- Refrigerant gas is not allowed for air exclusion.
- Maybe it is leakage, when relative vacuum degree can't reach -0.1MPa. If no leakage, please let the vacuum pump work again one to two hours.

Stop Valve

1. Stop valve operation and method

Attention:

- Component name as shown figures. Stop valve is closed when leaving the factory.
- Please use the suitable tools. The unit stop valve is not pipe socket sealed type. Forced open is forbidden, otherwise it will damage the valve.
- Lower operation pressure when low temperature refrigeration runtime for outdoor unit, in order to prevent the gas side stop valve pipe socket is frozen, please use silicon sealant to seal fully.
- Tighten the cover, please confirm whether there is refrigerant leakage.

2. Close the stop valve operation and method.

Please prepare Allen wrench (6 mm).

Open method: 1) Use Allen wrench then counterclockwise.

2) Turn the valve stem stops is open.

Close method: 1) Use Allen wrench then clockwise.

2) Turn the valve stem stops is close.

3. Valve deck attention

The valve must tighten the valve deck after operation.

4. Service port attention

Please use a lever operated filling hose. The valve must tighten the valve deck after operation.

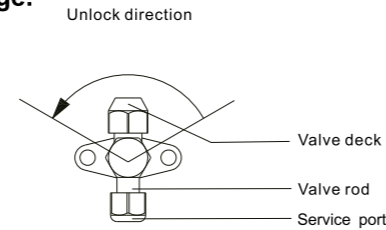

unit: mm

Type	4kW~6kW	8kW~10kW	12kW~16kW
Stop valve (liquid)	φ 9.52	φ 9.52	φ 9.52
Stop valve (gas)	φ 15.9	φ 15.9	φ 15.9

Leak detection

With soap and water or leak detector check whether each joint leakage.

Note: A is stop valve(liquid), B is stop valve(gas). C and D are connecting pipe port.

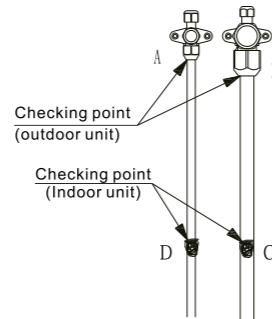

Heat insulation

Copper tube and drain pipe must be separately insulated to prevent condensation or water leakage.

1. The copper tube should be properly insulated using materials designed for insulating air conditioner pipe and heat resistive above 120°C, and flame retardant B1 level.
2. At least 15 mm of insulation layer thickness of copper pipe diameter $\leq \phi 9.52$, At least 20 mm of insulation layer thickness of copper pipe diameter $\geq \phi 9.52$.
3. Piping connection of the indoor unit, please use attached insulation in harmony navigate their insulating.

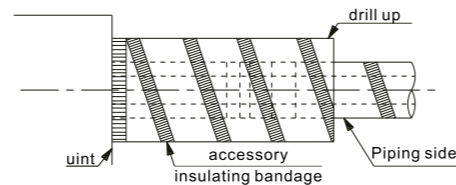

Refrigerant charging

1. Calculating additional refrigerant charge

The additional refrigerant charge required depends on the lengths and diameters of the outdoor unit and hydronic box liquid pipes.

If the length of the liquid side pipe is less than 15 meters it is no need to add more refrigerant, so calculating the added refrigerant the length of the liquid side pipe must subtract 15 meters.

2. Additional refrigerant charge

Model	Liquid side piping (mm)	Refrigerant	Additional refrigerant charge per meter of equivalent length of piping (kg)
4kW~6kW	9.52	R32	(L-15)x0.038
8kW~10kW	9.52	R32	(L-15)x0.038
12kW~16kW	9.52	R32	(L-15)x0.038

5 Electric Wiring

WARNING

- All electrical works must be carried out & checked by a qualified electrician and must adhere to the IET regulations, local and national legislation and industry best practice. The system must have its own independent power supply. An all pole isolating disconnect switch with at least 3mm contact separation must be installed.
- The power cord and connecting cable should be either as supplied with the unit or otherwise as specified in this manual.
- Do not attempt any electrical works yourself.
- An Earth Leakage Protector, Power Switch and Circuit Breaker or Fuse must be installed in the dedicated power supply or there is the risk of electric shock.
- The fuse specification of single-phase control panel is F5AL 250V;
- The grounding must be reliable. If grounding is not correct, it may lead to electric shock.
- All power cables should be properly secured with cable ties so that external forces cannot disconnect the wired from the terminals. Improper connections or insecure fastening can cause electric shocks or fire.
- If the supply cord is damaged, it must be replaced by the manufacturer, its service agent or similarly qualified persons in order to avoid a hazard.

CAUTION

- Do not connect the earth cable to gas or water pipes, telephone lines, lightning rods or the earth cables of other products.
- Once the indoor and outdoor unit have been switched on, do not cut off power off power supply in 1 minute, (the system automatically set) otherwise abnormal operation will be caused.
- Please connect the power cord and interconnecting cable according to the wiring diagram.
- Connect the wire firmly to the terminal block using crimps and secure in order to prevent external forces pulling on the wire causing risk of fire or electric shock.
- After the electrical connection is completed, all wires should be prevented from touching other parts such as tubing, compressor etc.

Electrical system and installation

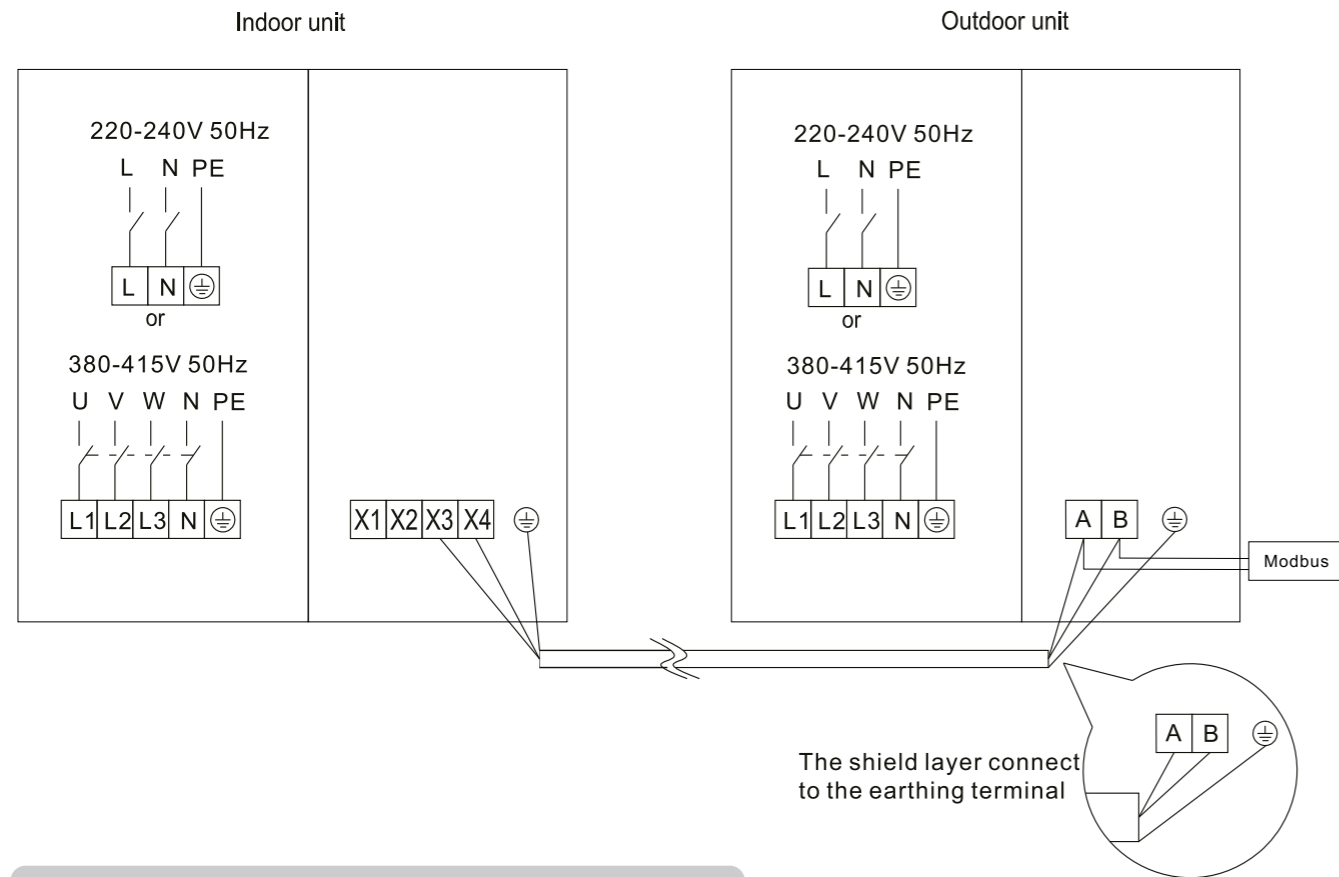

Indoor unit and outdoor unit wiring system

Recommended Specification for Power Line of Outdoor Unit (stand-alone power supply)

Model	Item	Powersupply	Nominal Cross Sectional AREA (mm ²)	Wiringlength(m)	Rated current Breaker(A)
4kW~6kW		220-240V 50Hz	4	20	18
8kW~10kW					19
12kW~16kW		220-240V 50Hz	6		36
		380-415V 50Hz	4		14

NOTE:

- In any case, the ground plane shall not disconnect the main power switch.
- Shall not use the damaged power cord, if found damaged should be replaced immediately.
- The air-conditioner use or power is a long time for the first time, need to preheat the turning on the power supply for at least 12 hours before use.
- In the table is said to gravitate diameter and length of continuous voltage drop within 2%, when the wiring for length exceeds the value in the table, please follow the relevant provisions of the selected wire and wire diameter.
- A creepage circuit breaker above the maxium current must be installed to avoid possible electric shocks.

Note

- When power wire is parallel with signal wire, put wires to their own wire tube and remain proper gap. The distance between the power wire and signal wire is appropriate. Recommended distance :below 10A -300mm, below 50A -500mm,
- The communication line between indoor units and outdoor units must use 3 core shielded wiring, and shielding layer is earth according to the requirements.
- Outdoor supply cords shall not be lighter than polychloroprene sheathed flexible cord with code designation 60245 IEC 57.Please refer to the unit wiring system for specifications.
- Outdoor supply cords shall not be lighter than polyvinyl chloride flexible cord with code designation 60227 IEC 53.Please refer to the unit wiring system for specifications.

Digital tube display

Refrigerating capacity selection

Capacity setting	
4 kW	001
6 kW	010
8 kW	011
10 kW	100
12 kW	101
14 kW	110
16 kW	111

Notes:

- ON "means1"
- ON "means0"

Fault Code

Code display	Failure
36	Invter OVV or UNDV protect
35	Invter OVC protect
H4	Low PRESS switch protect
H1	high PRESS switch protect
39	Invter high temp protect
C1	ODU Ambient temp sensor fault
C6	Suction temp sensor fault
E3	DISC temp too high protect
FH	Low DISC temp protect
E1	Four-way valve cut fault
C2	Defrosting temp sensor fault
3H	Invter fault start or out of step
J7	EEPROM fault
C3	DISC temp sensor fault
H4	Low PRESS switch protect
J2	ODU Comm fault with IDUs
3E	Invter ACC protect
3F	Invter PFC protect
31	Invter IPM protect
J3	Comm fault between main PCBCOMP Invter
J4	Comm fault between main PCB and Fan Invter
32	Invter hardware protect
37	Invter temp sensor fault
33	Invter software protect
F1	DISC PRESS sensor fault
F3	DISC PRESS too high protect
J5	Wrong ODU quantity setting and address setting

6 Trail Operation

Checking before trail operation

1. Indoor unit and outdoor unit is properly installed.
2. The piping and wiring is correct.
3. Refrigerant piping system is leak detection.
4. Heat insulation is perfect.
5. Ground wire is properly connected.
6. The length of the pipe and the additional quantity of refrigerant has been recorded.
7. Power supply voltage and rated voltage of air condition is equal.
8. Inlet and outlet of outdoor unit is not obstacles.
9. Open stop valve.
10. Switch on the power to let the air conditioner warm.

Trail operation

- 1) There is no vibration and abnormal sound.
- 2) The noise and air of outdoor unit impacts the normal life of local people.
- 3) No refrigerant leakage.

NOTE:

After turning on the power supply, immediately turned on or off when the reboot, air conditioner equipped with protection function, compressor delay start 5 minutes.

7 Maintenance Notice

Attention:

For maintenance or scrap, please contact authorized service centers.

Maintenance by unqualified person may cause dangers.

Feed air conditioner with R32 refrigerant, and maintain the air conditioner in strictly accordance with manufacturer's requirements. The chapter is mainly focused on special maintenance requirements for appliance with R32 refrigerant. Ask repairer to read after-sales technical service handbook for detailed information.

Qualification requirements of maintenance personnel

1. Special training additional to usual refrigerating equipment repair procedures is required when equipment with flammable refrigerants is affected. In many countries, this training is carried out by national training organisations that are accredited to teach the relevant national competency standards that may be set in legislation. The achieved competence should be documented by a certificate.
2. The maintenance and repair of the air conditioner must be conducted according to the method recommended by the manufacturer. If other professionals are needed to help maintain and repair the equipment, it should be conducted under the supervision of individuals who have the qualification to repair AC equipped with flammable refrigerant.

Inspection of the Site

Safety inspection must be taken before maintaining equipment with R32 refrigerant to make sure the risk of fire is minimized. Check whether the place is well ventilated, whether anti-static and fire prevention equipment is perfect. While maintaining the refrigeration system, observe the following precautions before operating the system.

Operating Procedures

1. General work area:
All maintenance staff and others working in the local area shall be instructed on the nature of work being carried out. Work in confined spaces shall be avoided. The area around the workspace shall be sectioned off. Ensure that the conditions within the area have been made safe by control of flammable material.
2. Checking for presence of refrigerant:
The area shall be checked with an appropriate refrigerant detector prior to and during work, to ensure the technician is aware of potentially toxic or flammable atmospheres. Ensure that the leak detection equipment being used is suitable for use with all applicable refrigerants, i.e. non-sparking, adequately sealed or intrinsically safe.
3. Presence of fire extinguisher:
If any hot work is to be conducted on the refrigeration equipment or any associated parts, appropriate fire extinguishing equipment shall be available to hand. Have a dry powder or CO2 fire extinguisher adjacent to the charging area.
4. No ignition sources:
No person carrying out work in relation to a refrigeration system which involves exposing any pipe work shall use any sources of ignition in such a manner that it may lead to the risk of fire or explosion. All possible ignition sources, including cigarette smoking, should be kept sufficiently far away from the site of installation, repairing, removing and disposal, during which refrigerant can possibly be released to the surrounding space. Prior to work taking place, the area around the equipment is to be surveyed to make sure that there are no flammable hazards or ignition risks.
'No Smoking' signs shall be displayed.
5. Ventilated Area (open the door and window):
Ensure that the area is in the open or that it is adequately ventilated before breaking into the system or conducting any hot work. A degree of ventilation shall continue during the period that the work is carried out. The ventilation should safely disperse any released refrigerant and preferably expel it externally into the atmosphere.

6. Checks to the refrigeration equipment:

Where electrical components are being changed, they shall be fit for the purpose and to the correct specification. At all times the manufacturer's maintenance and service guidelines shall be followed. If in doubt, consult the manufacturer's technical department for assistance. The following checks shall be applied to installations using flammable refrigerants:

- The charge size is in accordance with the room size within which the refrigerant containing parts are installed.
- The ventilation machinery and outlets are operating adequately and are not obstructed.
- If an indirect refrigerating circuit is being used, the secondary circuit shall be checked for the presence of refrigerant.
- Refrigeration pipe or components are installed in a position where they are unlikely to be exposed to any substance which may corrode refrigerant containing components, unless the components are constructed of materials which are inherently resistant to being corroded or are suitably protected against being so corroded.

7. Checks to electrical devices:

Repair and maintenance to electrical components shall include initial safety checks and component inspection procedures. If a fault exists that could compromise safety, then no electrical supply shall be connected to the circuit until it is satisfactorily dealt with. If the fault cannot be corrected immediately but it is necessary to continue operation, an adequate temporary solution shall be used. This shall be reported to the owner of the equipment so all parties are advised.

Initial safety checks shall include:

- That capacitors are discharged: this shall be done in a safe manner to avoid possibility of sparking.
- That no live electrical components and wiring are exposed while charging, recovering or purging the system.
- Keep continuity of earthing.

Inspection of Cable

Check the cable for wear, corrosion, overvoltage, vibration and check if there are sharp edges and other adverse effects in the surrounding environment. During the inspection, the impact of aging or the continuous vibration of the compressor and the fan on it should be taken into consideration.

Leakage check of R32 refrigerant

Note: Check the leakage of the refrigerant in an environment where there is no potential ignition source. No halogen probe (or any other detector that uses an open flame) should be used.

Leak detection method:

For systems with refrigerant R32, electronic leak detection instrument is available to detect and leak detection should not be conducted in environment with refrigerant. Make sure the leak detector will not become a potential source of ignition, and is applicable to the measured refrigerant. Leak detector shall be set for the minimum ignitable fuel concentration (percentage) of the refrigerant. Calibrate and adjust to proper gas concentration (no more than 25%) with the used refrigerant.

The fluid used in leak detection is applicable to most refrigerants. But do not use chloride solvents to prevent the reaction between chlorine and refrigerants and the corrosion of copper pipeline.

If you suspect a leak, then remove all the fire from the scene or put out the fire.

If the location of the leak needs to be welded, then all refrigerants need to be recovered, or, isolate all refrigerants away from the leak site (using cut-off valve). Before and during the welding, use OFN to purify the entire system.

Removal and Vacuum Pumping

1. Make sure there is no ignited fire source near the outlet of the vacuum pump and the ventilation is well.
2. Allow the maintenance and other operations of the refrigeration circuit should be carried out according to the general procedure, but the following best operations that the flammability is already taken into consideration are the key. You should follow the following procedures:
 - Remove the refrigerant.
 - Decontaminate the pipeline by inert gases.
 - Evacuation.
 - Decontaminate the pipeline by inert gases again.
 - Cut or weld the pipeline.
3. The refrigerant should be returned to the appropriate storage tank. The system should be blown with oxygen free nitrogen to ensure safety. This process may need to be repeated for several times. This operation shall not be carried out using compressed air or oxygen.
4. Through blowing process, the system is charged into the anaerobic nitrogen to reach the working pressure under the vacuum state, then the oxygen free nitrogen is emitted to the atmosphere, and in the end, vacuumize the system. Repeat this process until all refrigerants in the system is cleared. After the final charging of the anaerobic nitrogen, discharge the gas into the atmosphere pressure, and then the system can be welded. This operation is necessary for welding the pipeline.

Procedures of Charging Refrigerants

As a supplement to the general procedure, the following requirements need to be added:

- Make sure that there is no contamination among different refrigerants when using a refrigerant charging device. The pipeline for charging refrigerants should be as short as possible to reduce the residual of refrigerants in it.
- Storage tanks should remain vertically up.
- Make sure the grounding solutions are already taken before the refrigeration system is charged with refrigerants.
- After finishing the charging (or when it is not yet finished), label the mark on the system.
- Be careful not to overcharge refrigerants.

Scrap and Recovery

Scrap:

Before this procedure, the technical personnel shall be thoroughly familiar with the equipment and all its features, and make a recommended practice for refrigerant safe recovery. For recycling the refrigerant, shall analyze the refrigerant and oil samples before operation. Ensure the required power before the test.

1. Be familiar with the equipment and operation.
2. Disconnect power supply.
3. Before carrying out this process, you have to make sure:
 - If necessary, mechanical equipment operation should facilitate the operation of the refrigerant tank.
 - All personal protective equipment is effective and can be used correctly.
 - The whole recovery process should be carried out under the guidance of qualified personnel.
 - The recovering of equipment and storage tank should comply with the relevant national standards.

- 4.If possible, the refrigerating system should be vacuumized.
- 5.If the vacuum state can't be reached, you should extract the refrigerant in each part of the system from many places.
- 6.Before the start of the recovery, you should ensure that the capacity of the storage tank is sufficient.
- 7.Start and operate the recovery equipment according to the manufacturer's instructions.
- 8.Don't fill the tank to its full capacity (the liquid injection volume does not exceed 80% of the tank volume).
- 9.Even the duration is short, it must not exceed the maximum working pressure of the tank.
- 10.After the completion of the tank filling and the end of the operation process, you should make sure that the tanks and equipment should be removed quickly and all closing valves in the equipment are closed.
- 11.The recovered refrigerants are not allowed to be injected into another system before being purified and tested.

Note: The identification should be made after the appliance is scrapped and refrigerants are evacuated. The identification should contain the date and endorsement. Make sure the identification on the appliance can reflect the flammable refrigerants contained in this appliance.

Recovery:

- 1.The clearance of refrigerants in the system is required when repairing or scrapping the appliance. It is recommended to completely remove the refrigerant.
- 2.Only a special refrigerant tank can be used when loading the refrigerant into the storage tank. Make sure the capacity of the tank is appropriate to the refrigerant injection quantity in the entire system. All tanks intended to be used for the recovery of refrigerants should have a refrigerant identification (i.e. refrigerant recovery tank). Storage tanks should be equipped with pressure relief valves and globe valves and they should be in a good condition. If possible, empty tanks should be evacuated and maintained at room temperature before use.
- 3.The recovery equipment should be kept in a good working condition and equipped with equipment operating instructions for easy access. The equipment should be suitable for the recovery of R32 refrigerants. Besides, there should be a qualified weighting apparatus which can be normally used. The hose should be linked with detachable connection joint of zero leakage rate and be kept in a good condition.
Before using the recovery equipment, check if it is in a good condition and if it gets perfect maintenance. Check if all electrical components are sealed to prevent the leakage of the refrigerant and the fire caused by it. If you have any question, please consult the manufacturer.
- 4.The recovered refrigerant shall be loaded in the appropriate storage tanks, attached with a transporting instruction, and returned to the refrigerant manufacturer. Don't mix refrigerant in recovery equipment, especially a storage tank.
- 5.The space loading R32 refrigeration can't be enclosed in the process of transportation. Take anti electrostatic measures if necessary in transportation. In the process of transport, loading and unloading, necessary protective measures must be taken to protect the air conditioner to ensure that the air conditioner is not damaged.
- 6.When removing the compressor or clearing the compressor oil, make sure the compressor is pumped to an appropriate level to ensure that there is no residual R32 refrigerants in the lubricating oil. The vacuum pumping should be carried out before the compressor is returned to the supplier. Ensure the safety when discharging oil from the system.

DE-COMMISSIONING, DISMANTLING & DISPOSAL

This product contains refrigerant under pressure, rotating parts, and electrical connections which may be a danger & cause injury. All work must only be carried out by competent persons using suitable protective clothing and safety precautions.



Read the Manual



Risk of Electric Shock

RoHS



Unit is Remotely controlled
& may start without warning



1. Isolate all sources of electrical supply to the unit including any control system supplies switched by the unit. Ensure that all points of electrical and gas isolation are secured in the OFF position. The supply cables and gas pipe work may then be disconnected and removed. For points of connection refer to unit installation instructions.
2. Remove all refrigerant from each system of the unit into a suitable container using a refrigerant reclaim or recovery unit. This refrigerant may then be reused, if appropriate, or returned to the manufacturer for disposal. Under NO circumstances should refrigerant be vented to atmosphere. Where appropriate, drain the refrigerant oil from each system into a suitable container and dispose of according to local laws and regulations governing disposal of oily wastes.
3. Packaged units can generally be removed in one piece after disconnection as above. Any fixing down bolts should be removed and then unit lifted from position using the points provided and equipment of adequate lifting capacity. Reference MUST be made to the unit installation instructions for unit weight and correct methods of lifting. Note that any residual or spilt refrigerant oil should be mopped up and disposed of as described above.
4. After removal from position the unit parts may be disposed of according to local laws and regulations.
5. Meaning of crossed Out wheeled dustbin: Do not dispose of electrical appliances as unsorted municipal waste, use separate collection facilities. Contact your local government for information regarding the collection systems available. If electrical appliances are disposed of in landfills or dumps, hazardous substances can leak into the groundwater and get into the food chain, damaging your health and well being. When replacing old appliances with new ones, the retailer is legally obligated to take back your old appliance for disposals at least free of charge.

SEVRA
Innovative Climate Solutions

The exclusive importer of the SEVRA brand in Poland:
WIENKRA Sp. z o. o.

www.wienkra.pl

www.sevra.pl

Kraków:

ul. Kotlarska 34, 31-539 Kraków
 ul. Rzemieślnicza 20C, 30-347 Kraków
 wienkra@wienkra.pl

Warszawa - Janki:

ul. Sokołowska 15, 05-090 Warszawa
 wienkra-waw@wienkra.pl

Wrocław:

Al. Armii Krajowej 61, 50-541 Wrocław
 wienkra-wro@wienkra.pl